

INSTALLATION INSTRUCTIONS

1092 SierraSeries® TOILET PARTITIONS

WITH HEAVY-DUTY HARDWARE

IMPORTANT:
Storage and Handling Information on last page.
For faster, easier installation, please review
these instructions thoroughly prior to
installation.

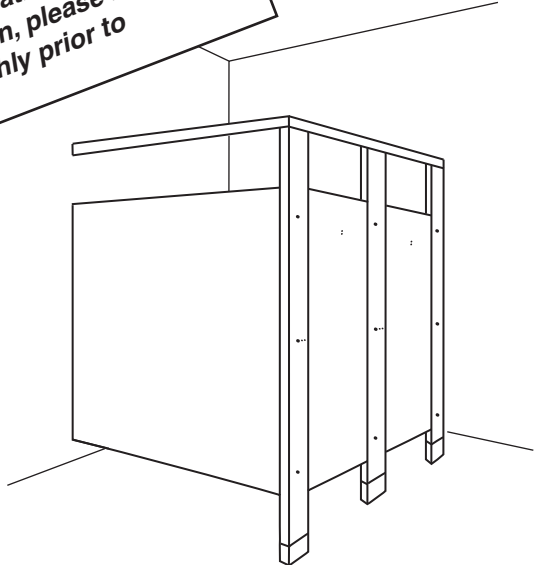

Available in Overhead Braced
Mounting Configuration Only

**Heavy-Duty
Hardware
Identifying Parts:**

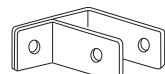

F-Bracket

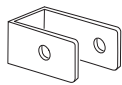

U-Bracket

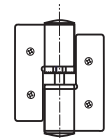

Hinges

HEAVY-DUTY HARDWARE

Table of Contents

| | | |
|----|--|--------------|
| A. | Parts List..... | Page 2 |
| B. | Recommended Tools | Page 3 |
| C. | Helpful Hints | Page 3 |
| D. | Installation Instructions | Page 4 – 19 |
| | Step 1. Lay Out Floor Anchor Locations | Page 4 |
| | Step 2. Install Floor Anchors..... | Page 5 |
| | Step 3. Rough Level Floor Anchors | Page 6 |
| | Step 4. Install Wall Brackets | Page 7 |
| | Step 5a. Install Stile Nearest Wall..... | Page 8 |
| | Step 5b. Install Wall Posts (if required) | Page 9 |
| | Step 6a. Install Stile Brackets for Perpendicular Panels | Page 10 |
| | Step 6b. Install Stile Brackets for Inline Panels | Page 11 |
| | Step 7. Position Panel | Page 12 |
| | Step 8. Install Adjacent Stile | Page 13 |
| | Step 9. Install Additional Compartment(s) | Page 14 |
| | Step 10. Install Doors..... | Page 15 - 17 |
| | Step 11. Install Headrail and Curtain Track (optional)..... | Page 18 |
| | Step 12. Install Shoes | Page 19 |
| | Step 13. Finishing and Cleanup..... | Page 19 |
| | Step 14. Finished Installation | Page 20 |









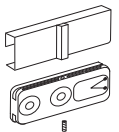

HEAVY-DUTY HARDWARE PARTS LIST

HEAVY-DUTY HARDWARE

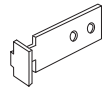



Mounting Screws

-  1002499 Sheet Metal Screw - 7/16", #12 x 7/16" (M5.5 x 11mm) pin-in-head Torx screw to attach mounting brackets-to-panels and headrail-to-stiles
-  1002664 Button Head Screw - 3/8", #10-24 x 3/8" (M4.8 x 10mm) pin-in-head Torx screw to attach to sex-bolt fastener through 1/2" panel
-  1002665 Button Head Screw - 5/8", #10-24 x 5/8" (M4.8 x 16mm) pin-in-head Torx screw to attach to sex-bolt fastener through 3/4" stiles/doors
-  1002666 Sex Bolt - 1/4" Diameter, 1/2" Barrel, #10-24 (4.8mm) pin-in-head Torx fastener for all through-bolted locations
-  1002495 Wall Screw - 2", #12 x 2" (M5.5 x 50mm) pin-in-head Torx screw for attaching wall brackets to stud backing (*not to scale*)
-  1000077 Flat Head Latch Screw - 1/4-20 x 1" (M6.1 x 25mm) Phillip screw for attaching Latch Track to brass inserts in door
-  1002491 Machine Screw - 1/2", 1/4-20 x 1/2" (M6.1 x 13mm) pin-in-head Torx screw for attaching Hinges and Door Stops to brass inserts in door

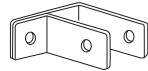

Door Hardware

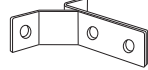
-  1001492 Latch Packet
(contains: Latch Track, Latch Cover, Setscrew and Flathead Latch screw)
-  1000900 Allen Wrench - 5/64" (2mm)
Allen Wrench for Setscrew to secure Latch Cover to Latch Track (for 1001492 Latch Packet)
-  1001518 I/S or O/S Inline Stile Keeper
Keeper for I/S and O/S doors latching to inline stiles
-  1000188 I/S Perpendicular Stile Keeper
Keeper for I/S doors latching to perpendicular stiles
-  1001675 I/S Wall-Mounted Keeper
Keeper for I/S doors latching to perpendicular walls
-  1000192 O/S Alcove Keeper
Keeper for O/S doors latching to perpendicular stiles or to walls
-  1000312 Door Handle Packet
(Contains: Door Handle and Mounting Screws)
-  1000869 Clothes Hook
-  1002510 Door Stop







Mounting Brackets

-  1000975 F-Bracket
Bracket to attach 1/2" panel to perpendicular wall
-  1000972 U-Bracket
Bracket to attach 1/2" panel to perpendicular 3/4" stile
-  1000974 Y-Bracket
Bracket to attach 3/4" stile to perpendicular wall
-  1000282 Alcove Bracket
Bracket to attach 1/2" panel to inline 3/4" stile
-  1002322 45° Angle Bracket
Bracket to attach panels/stiles/walls at non-90° angles



Hinge Hardware

-  1002331 J-Hinge Packet
 -  1002156 Hinge Cam
 -  1002330 L-Hinge Packet
- NOTE: Shading added to distinguish L- and J- hinges.**

Headrail Hardware

-  1000978 Headrail End Cap
-  1002385 84" Headrail
-  1000345 120" Headrail
-  1000375 Curtain Track
-  1000862 Curtain Carrier Packet
(7 hooks and screws included)
-  1000927 Headrail Bracket

Stile Hardware

-  1002189 Shoe Retainer Screw
-  1002185 Shoe Retainer Clip
-  1002701 Floor Anchor Packet

REPLACEMENT SHOE GUIDE

| Stile Width | Bobrick Part Number |
|-------------|---------------------|
| 3" | 1002175 |
| 4" | 1002176 |
| 5" | 1002184 |
| 6" | 1002177 |
| 8" | 1002178 |
| 10" | 1002179 |
| 12" | 1002180 |
| 16" | 1002181 |
| 20" | 1002182 |
| 24" | 1002183 |

RECOMMENDED TOOLS

HELPFUL HINTS

CAUTION: Be sure to use proper safety gear.

1.  Chalk Line
2.  Plumb-bob
3.  Pliers
4.  Tape Measure
5.  Contractor's Pencil
6.  Electric and/or Battery-Powered Drill
7.  Drill Bits
#19 (.166") M4.2
3/16" (4.7mm)
17/64" (6.7mm)
3/8" (9.5mm) for Concrete/Masonry
7/16" (11mm)
8.  Screwdrivers/Screwdriver Bits slotted and Phillips, #2 and #3
9.  Pin-in-Head Torx Driver
(supplied by Bobrick)
10.  Hex Driver Shank Extension
11.  Shims
12.  Adjustable Supports
1-1/2" to 12" (40 - 105mm)
13.  Level
14.  Wrench - 9/16" (14mm) open end (2 reqd. for adjusting hex nuts on anchors)
15.  Allen Wrench - 5/64" (2mm)
(supplied by Bobrick)
16.  Hack Saw or Miter Saw
17.  Hammer
18.  Safety Glasses



1. Organize hardware necessary to install each component.
2. When calculating distances to centerlines, stiles and doors are 3/4" (19mm) thick; panels are 1/2" (13mm) thick.
3. Use panel-to-stile offsets indicated on the Layout Sheets.
4. Doors are NOT pre-drilled for robe hooks.
5. Stiles are NOT pre-drilled for keepers (to allow easier stile leveling and greater field adjustment).
6. Remove debris from all drilled holes.
7. Through-drill all holes through Solid Color Reinforced Composite material.

RECOMMENDED HOLE SIZES:

17/64" (6.7mm): THROUGH-DRILLED HOLE: to attach all through-bolted brackets, latch keepers and robe hooks to panels or stiles.

3/16" (4.7mm) PILOT HOLE: to attach all non-through-bolted brackets to panels or stiles.

NOTE: Drill COMPLETELY through material. Do NOT drill through brackets.

#19 (.166") x 2" (M4.2 x 50mm) PILOT HOLE: to attach all wall brackets to stud backing.

8. Drill holes perpendicular to material.
NOTE: Do NOT drill holes or attach screws to material at an angle.
9. To avoid stripping material, tighten 1002499 Sheet Metal Screws with moderate drill speed and medium torque setting (~15).
10. To reduce stile leveling necessary, rough level floor anchors before installing stiles (see STEP 3, pg 6).

IMPORTANT NOTES

1. Walls and floors in buildings are NOT level. For quality installation, plumb brackets and components in all three dimensions using a plumb-bob or level prior to marking, drilling or installing.
2. Structural support in walls and floors is not furnished by Bobrick. Confirm adequate backing is present in wall and floors prior to installation.
3. This installation booklet must be used in conjunction with the Bobrick Layout Sheets.
4. Verify receipt of appropriate hardware by cross-referencing against hardware list.

HEAVY-DUTY HARDWARE

STEP 1 LAY OUT FLOOR ANCHOR LOCATIONS

PARTS NEEDED:

Bobrick Layout Sheets

TOOLS NEEDED:

Chalk Line
Contractor's Pencil
Measuring Tape

LAYOUT EXAMPLE.

Fig. 1a: Floor Anchor Locations for Closed Alcove Layout with Adjoining Front-Entry Stall.

NOTE: Centerline of Alcove Stile is not inline with centerline of Alcove Panel. Match actual component dimensions and orientation with those on Layout Sheets.

◇ Obtain Dimension from Bobrick Layout Sheet.

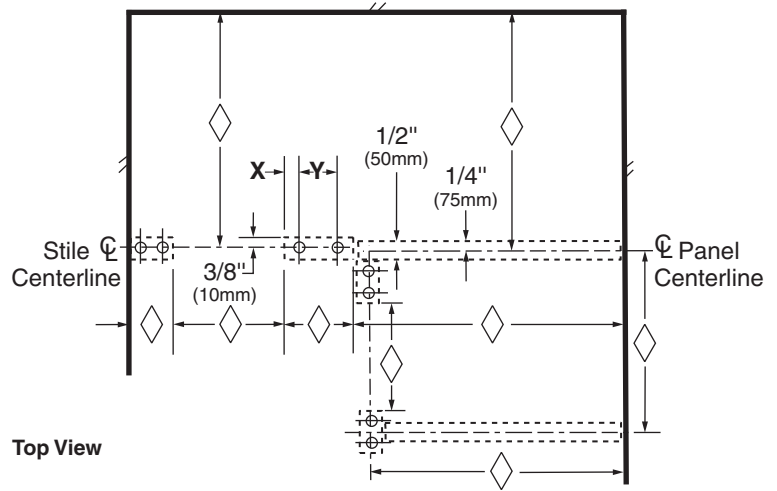

HEAVY-DUTY HARDWARE

- Using measuring tape, verify Layout Sheet with actual room dimensions.
- Determine component locations in accordance with Layout Sheets.
- At each end of the room, use tape measure and contractor's pencil to mark centerlines of alcove compartment. Since walls in the room may not be square, confirm component layouts by checking dimensions parallel to the back wall with those based off of perpendicular side walls.

NOTE: Stile centerline = Distance from wall to outside edge of stile (from Layout Sheets) minus 3/8" (10mm).

- Snap Chalk Line between marks made in STEP C to mark partition centerline on the floor.
- Starting from the side wall, measure and mark edges of stiles and floor anchors hole locations on chalk line drawn in STEP D, according to Layout Sheet. Refer to drilling table below for center-to-center distance between anchors.

NOTE: Centerline of Floor Anchor is 5/8" (16mm) from edge of stile (X-dimension in table below); dimension on 3" stile is 1-1/2" (38mm).

- Mark centerlines of components for all other compartments on floor (as indicated in Layout Sheets).
- Mark all Floor Anchor hole locations on lines on floor made in STEP F.

| DRILLING TABLE FOR DRILLING FLOOR OR CEILING ANCHORS | | | |
|--|--------------|---------------|----------------|
| Stile Size (width) | No. of Holes | X Dim. | Y Dim. |
| 3" (8cm) | 1 | 1 1/2" (38mm) | — |
| 4" (10cm) | 2 | 5/8" (16mm) | 2 3/4" (7cm) |
| 5" (13cm) | 2 | 5/8" (16mm) | 3 3/4" (10cm) |
| 6" (15cm) | 2 | 5/8" (16mm) | 4 3/4" (12cm) |
| 8" (20cm) | 2 | 5/8" (16mm) | 6 3/4" (17cm) |
| 10" (25cm) | 2 | 5/8" (16mm) | 8 3/4" (22cm) |
| 12" (30cm) | 2 | 5/8" (16mm) | 10 3/4" (27cm) |
| 16" (41cm) | 2 | 5/8" (16mm) | 14 3/4" (38cm) |
| 20" (51cm) | 2 | 5/8" (16mm) | 18 3/4" (48cm) |
| 24" (61cm) | 2 | 5/8" (16mm) | 22 3/4" (58cm) |

Fig. 1b: Detail of Typical Stile.

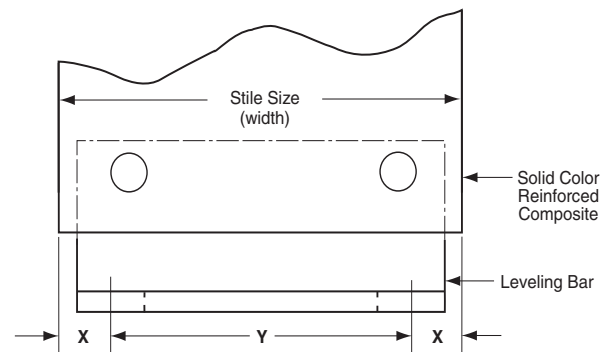

NOTE: 16", 20", 24" (41, 51, 61cm) stiles have 2 leveling bars. Use the 2 outside slots for the 2 anchors.

STEP 2 INSTALL FLOOR ANCHORS

Fig. 2a: Finished Detail of Floor Anchor.

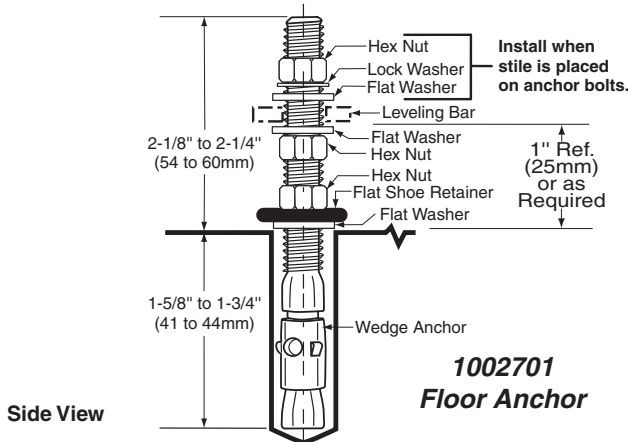
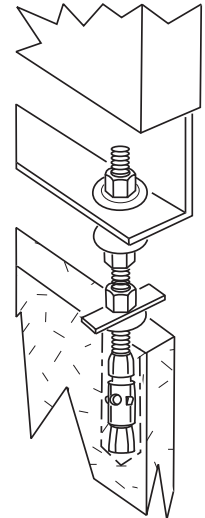

Fig. 2b: Floor Anchor Attached to Stile. (3-Dimensional View)



PARTS NEEDED:

1002701 Floor Anchor Packet
(includes: 3 Hex Nuts, 3 Flat Washers, Wedge Anchor, Lock Washer, Flat Shoe Retainer)

TOOLS NEEDED:

Hammer
Drill
3/8" (9.5mm) Concrete/Masonry Bit
Wrench (Adjustable or with 9/16" open end)

HINTS/NOTES:

3/8" x 2" (M9.5 x 50mm) hole needed to install 1002701 Floor Anchor. Use concrete/masonry drill bit.
Floor Anchors for wood floors are available upon request.

- A. Drill a 3/8" (9.5mm) hole to 2" (50mm) minimum depth.

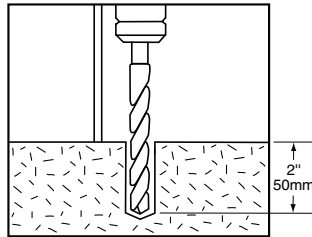

- B. Remove all loose material/debris from hole.

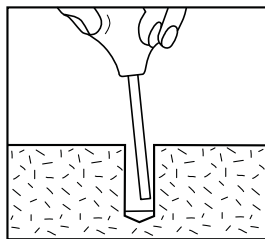

- C. Add Flat Washer, Flat Shoe Retainer, Hex Nut to Wedge Anchor so that Flat Washer is 1-7/8" (48mm) from the bottom of the anchor to ensure proper installation depth. Thread 2nd Hex Nut loosely to top of Anchor to prevent stripping or damaging threads during installation.

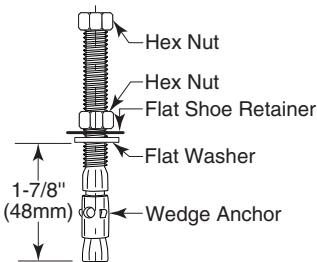

- D. Insert Anchor into hole with threaded end up. Use hammer to drive the Anchor into hole until Flat Washer is flush with concrete surface (depth set in STEP C).

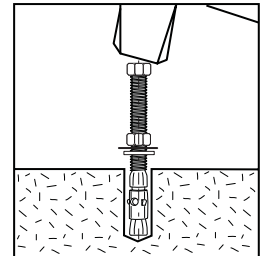

- E. Use Wrench to tighten Hex Nut until anchor is firmly set (2-4 full turns past finger tight position). Anchor bolt will move up approx. 1/16" (1.6mm) for every full turn of Hex Nut.

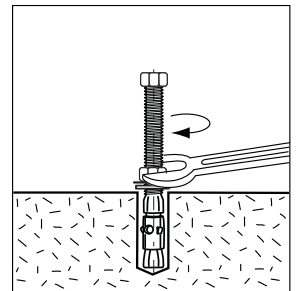

- F. Spin down top Hex Nut. Add Flat Washer.

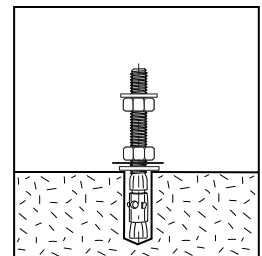

NOTE: Do NOT add 3rd Hex Nut, Lock Washer, and 3rd Flat Washer until stiles are attached to Floor Anchor.

STEP 3 ROUGH LEVEL FLOOR ANCHORS

PARTS NEEDED:

None

TOOLS NEEDED:

Level

HINTS/NOTES:

To quickly level a long bank of toilet partitions, attach string to the Floor Anchors located at each end of the room and level the string. Screw/un-screw Hex Nuts to set Flat Washers (from STEP 2F, pg. 5) on all Floor Anchors to the height of the string.

- Place level on the Flat Washers of the two (2) Floor Anchors installed nearest wall (from STEP 2F, pg. 5).
- Tighten/loosen 2nd Hex Nut on one of the Floor Anchors until the two Flat Washers are level.
- Repeat rough leveling procedure for all Floor Anchors in room.

Fig. 3: Rough Leveling Floor Anchors.

HEAVY-DUTY HARDWARE

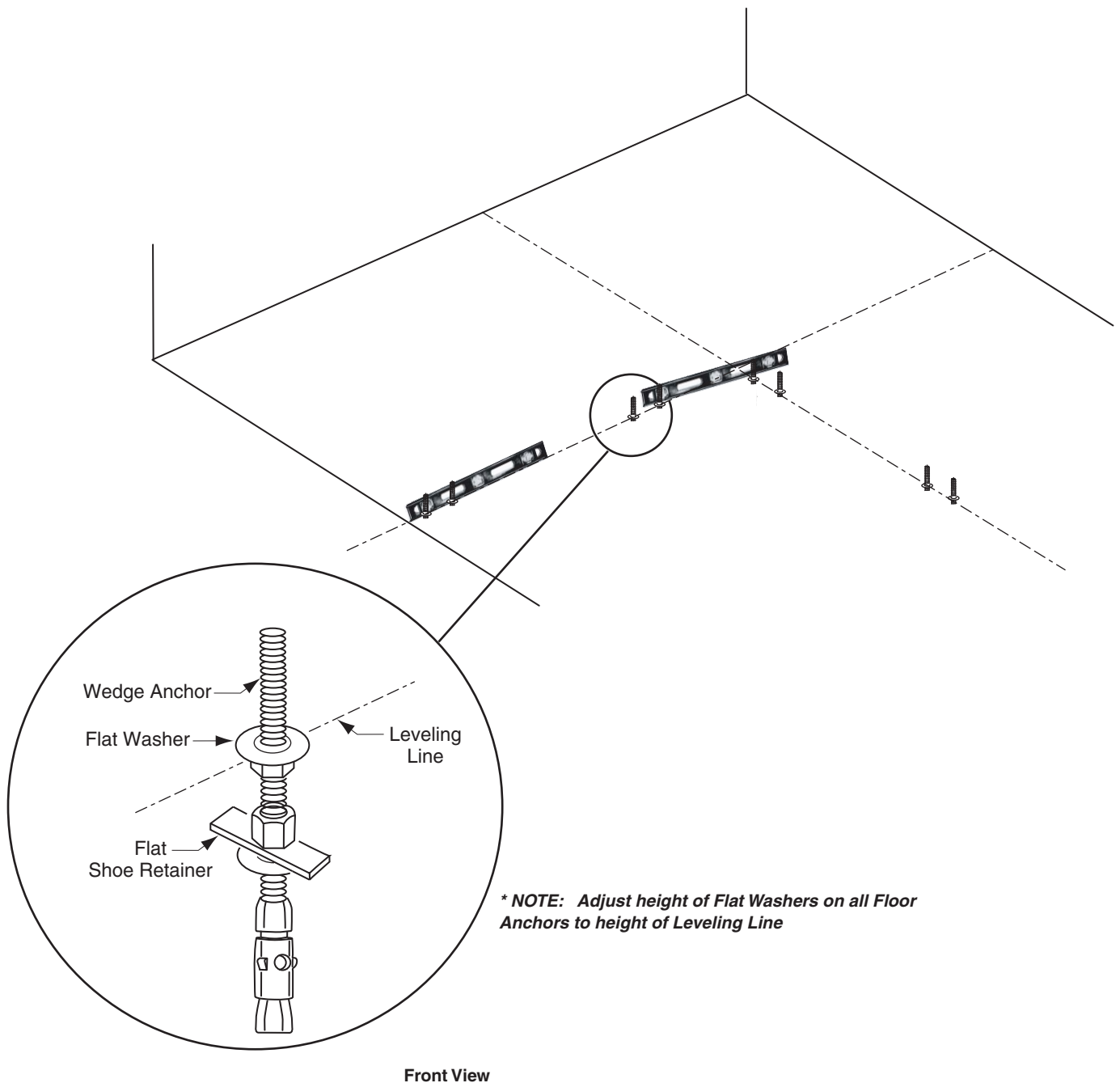

STEP 4 INSTALL WALL BRACKETS

PARTS NEEDED:

- 1000975 F-Brackets
- 1000974 Y-Brackets
- 1002495 Wall Screws - 2"

TOOLS NEEDED:

- Tape Measure
- Contractor's Pencil
- Level or Plumb-bob
- Drill

- #19 (.166" or 4.2mm) Drill Bit
- T27 Pin-in-head Torx Driver
- Hex Driver Shank Extension

HINTS/NOTES:

#19 (.166") x 2" (M4.2 x 50mm) pilot hole needed to fasten wall brackets to stud backing using 1002495 Wall Screws.

INSTALLING WALL BRACKETS:

- A. Use tape measure and level to plumb, measure and mark centerlines of all stiles and panels on walls.
- B. Using the 1000975 F-Bracket and 1000974 Y-Bracket as templates, measure and mark the location of all bracket mounting holes (see Fig. 4a).
- C. Drill #19 (.166") x 2" (M4.2 x 50mm) pilot hole into stud backing or use other anchors appropriate for wall construction (not furnished by Bobrick).
- D. Secure wall brackets to wall with 1002495 Wall Screws using the T27 Driver and Hex Driver Shank Extension attached to drill.

Fig. 4a: Bracket Mounting Heights for Closed Alcove with Adjoining Front-Entry Stall Layout.

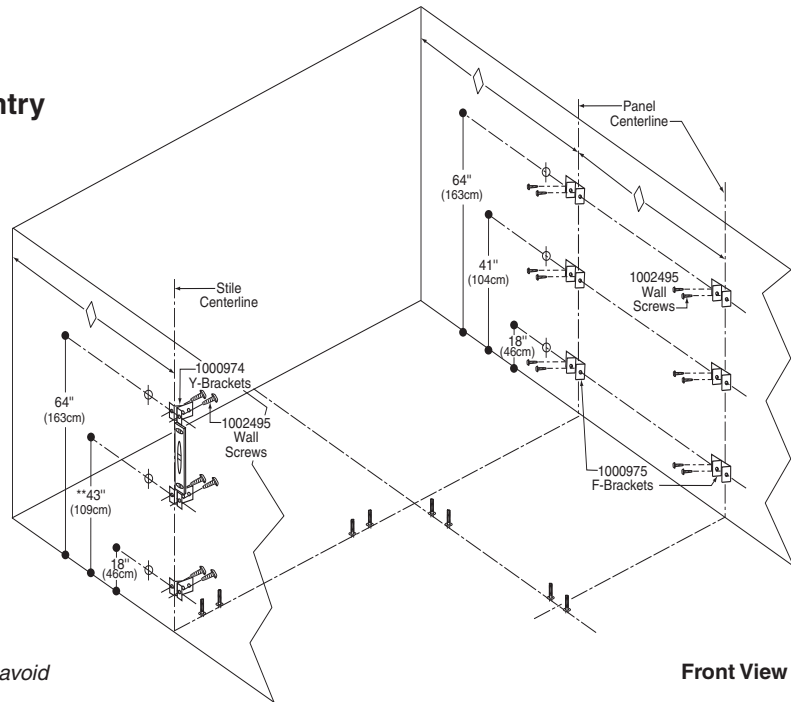

NOTE: Panel centerline is not always on stile centerline. Refer to Bobrick Layout Sheets for panel offsets.

⊕ These mounting points require wall backing.

◇ Obtain dimension from Bobrick Layout Sheet.

★★ Mount Bracket for Stiles at specified location to avoid interference with hardware.

Fig. 4b: Mounting Brackets for Front-Entry Corner Layout.

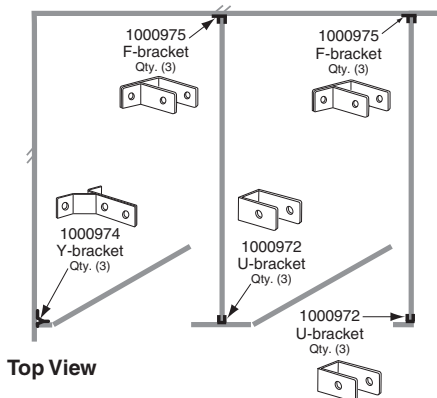
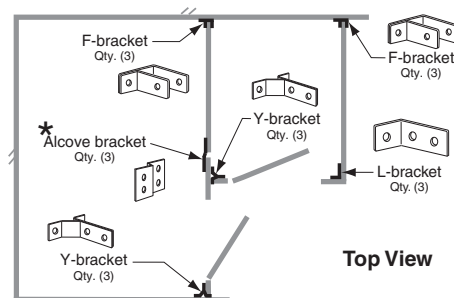

Fig. 4c: Mounting Brackets for Closed Alcove with Adjoining Front-Entry Stall.



*** NOTE: 1002664 Button-Head Screw - 3/8" is used to secure 1002666 Sex Bolt on panel side of 1000282 Alcove Bracket.**

HEAVY-DUTY HARDWARE

STEP 5a INSTALL STILE NEAREST WALL

PARTS NEEDED:

- Stile connecting to wall
- Remaining components of 1002701 Floor Anchor
(i.e., Flat Washer, Lock Washer, and Hex Nut)
- 1002665 Button Head Screw - 5/8"
- 1002666 Sex Bolt - 1/4" diameter, 1/2" barrel
- 1002245 Wall Post Packet

TOOLS NEEDED:

- Contractor's Pencil
- Drill
- 17/64" (6.7mm) Drill Bit
- T27 Pin-in-head Torx Driver
- Wrench (Crescent or with 9/16" open end)

HINTS/NOTES:

17/64" (6.7mm) through-drilled hole needed to through-bolt brackets-to-stiles with 1002666 Sex Bolts.

- Place stile leveling bar on top of 2nd Flat Washer of Floor Anchor(s).
- Level stile vertically. Use contractor's pencil to mark hole locations on stile (using the 1000974 Y-Brackets installed on wall as a template).
- Remove stile and drill 17/64" (6.7mm) hole through stile at locations marked in STEP B.
- Again place stile leveling bar on top of 2nd Flat Washer of Floor Anchor(s).
- Place 1002666 Sex Bolt in the drilled hole on the exterior side of stile.
- Secure Sex Bolts to Y-Brackets with 1002665 Button Head Screws - 5/8" using drill equipped with T27 Driver.
- Add Flat Washer, Lock Washer and Hex Nut to Floor Anchor above stile leveling bar.
- Tighten Hex Nuts above/below leveling bar with wrench.

HEAVY-DUTY HARDWARE

Fig. 5a: Installing Stile Nearest Wall.

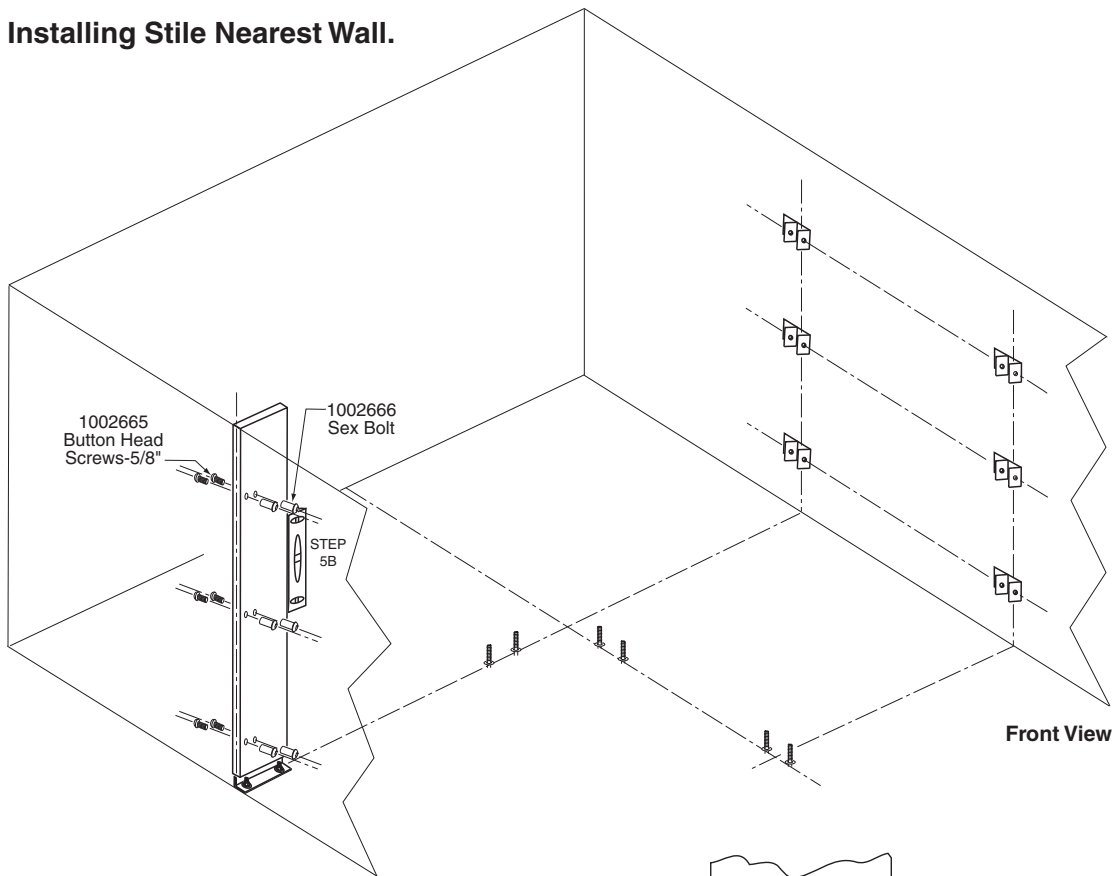
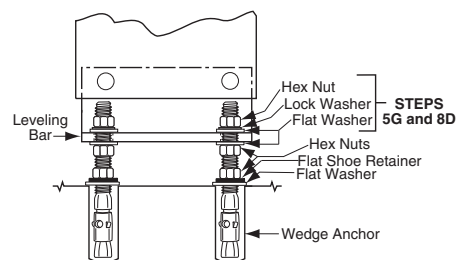

Fig. 5b: Stile Secured to Floor Anchor.



STEP 5b INSTALL WALL POSTS (If required)

HINTS/NOTES:

#19 (.166") x 2" (M4.2 x 50mm) pilot hole needed to fasten wall posts to stud backing using 1002495 Wall Screws.

INSTALLING WALL POSTS:

A. Determine the hole locations for required door swing for the Wall Post 1" x 1-1/2" (25 x 40mm). Outside edge of Wall Post should be in line with the outside edge of keeping stile.

NOTE: The wall must have adequate backing at mounting locations to support weight of door when hung.

B. Level Wall Post in both directions on wall. Mark mounting hole locations on wall.

C. Drill #19 (.166") x 2" (M4.2 x 50mm) pilot hole into stud backing.

D. Secure Wall Post to wall with (5) 1002495 Wall Screws - 2". Install (2) Post End Caps and (5) Mounting Hole Plugs.

E. Attach door hinge with fasteners provided in 1002245 Wall Post Packet.

Fig. 5c: Installing Wall Posts to Wall.

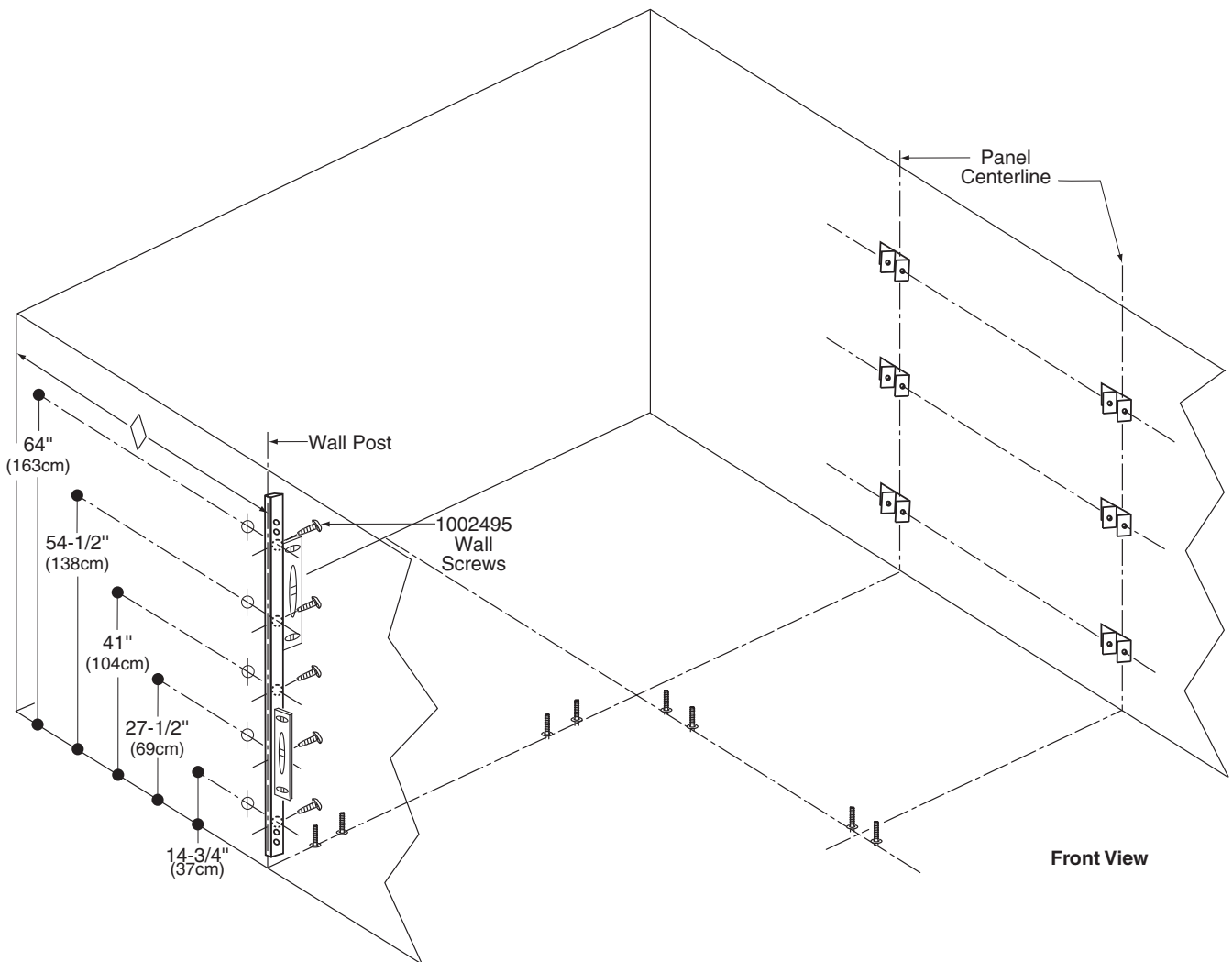

HEAVY-DUTY HARDWARE

NOTE: Panel centerline is not always on the stile centerline. Refer to Bobrick Layout Sheets for panel offsets.

⊕ These mounting points require wall backing.

◇ Obtain dimension from Bobrick Layout Sheet.

STEP 6a INSTALL STILE BRACKETS FOR PERPENDICULAR PANELS

PARTS NEEDED:

- Layout Sheets
- 1002664 Button Head Screw - 3/8"
- 1002665 Button Head Screw - 5/8"
- 1002666 Sex Bolt - 1/4" diameter, 1/2" barrel
- 1000972 U-Bracket
- 1000282 Alcove Bracket

TOOLS NEEDED:

- Drill
- T27 Pin-in-head Torx Driver
- Hex Driver Shank Extension
- 17/64" Drill Bit
- Tape Measure
- Level
- Contractor's Pencil

HINTS/NOTES:

17/64" (6.7mm) through-drilled hole needed to through-bolt brackets-to-stiles using 1002666 Sex Bolts.

- A. Locate appropriate stile on Layout Drawings.
- B. Before drilling holes for brackets, confirm correct: 1) width of stile and 2) hinge drilling pattern on stile with Layout Sheets. First determine the exterior side of stile and then mark interior face for bracket hole locations .

For **Outswing** doors, brass inserts on stile should be located on the **OUTSIDE** of compartment.

For **Inswing** doors, brass inserts on stile should be located on the **INSIDE** of compartment.

ATTACHING 1000972 U-BRACKETS:

- C. Use tape measure and level to measure and mark the centerlines for the three (3) 1000972 U-Brackets at the heights shown in Fig. 6a at the offsets indicated in the Layout Sheets.
- D. Use drill equipped with high quality 17/64" (6.7mm) bit to drill a hole through stile at the marked locations marked in STEP C.
- E. Place 1002666 Sex Bolt - 1/4" diameter, 1/2" barrel in the hole on the exterior side of stile.
- F. Secure U-Bracket to Sex Bolt with 1002665 Button Head Screw - 5/8" using drill equipped with T27 Driver and Hex Driver Shank Extension.
- G. Repeat above steps for all stiles mounting to perpendicular panels.

**Fig. 6a: Installing U-Brackets to Stile.
(for Perpendicular Panels)**

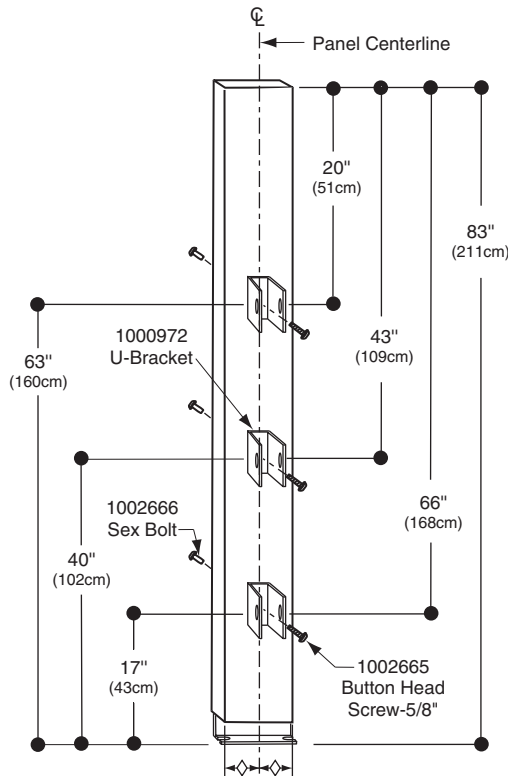

◇ Obtain dimension from Bobrick Layout Sheet.

(Refer to examples on page 7)

Inside View

STEP 7 POSITION PANEL

PARTS NEEDED:

Panel

TOOLS NEEDED:

Adjustable Supports (2)

- Place adjustable supports in position to hold panel 12" (31cm) above the floor.
- Place panel on the adjustable supports. Slide panel into the 1000975 F-Brackets attached to wall.

NOTE: Do NOT secure panel to F-Brackets on wall at this time.

Fig. 7: Positioning Panel with Adjustable Supports.

HEAVY-DUTY HARDWARE

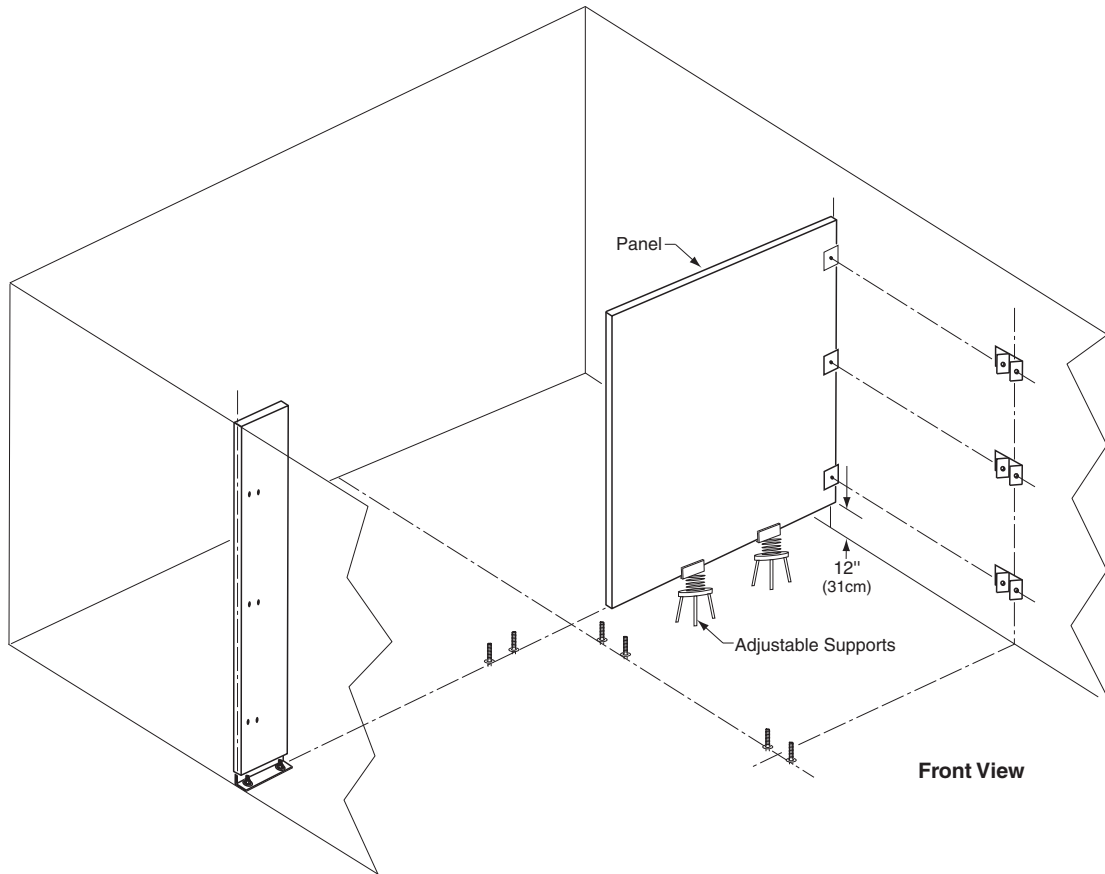

STEP 8 INSTALL ADJACENT STILE

PARTS NEEDED:

Stile
1002499 Sheet Metal Screws - 7/16"
1002385 Headrail
1002664 Button Head Screw - 3/8"
1002666 Sex Bolt - 1/4" diameter, 1/2" barrel
Remaining components of 1002701 Floor Anchor
(i.e., Flat Washer, Lock Washer, and Hex Nut)

TOOLS NEEDED:

Wrench (Crescent or with 9/16" open end)
Drill
T27 Pin-in-head Torx Driver
3/16" (4.7mm) Drill Bit
Shims
Level

HINTS/NOTES:

3/16" (4.7mm) pilot hole size needed to fasten brackets-to-panels using 1002499 Sheet Metal Screws.

NOTE: Drill COMPLETELY through material. Do NOT drill through F-Brackets.

- A. Set leveling bar of stile on top of Flat Washers of adjacent set of Floor Anchors.
- B. Level stiles by placing length of 1002385 Headrail over two adjacent stiles.
- C. Level stile by tightening/loosening 2nd Hex Nut of Floor Anchors.
- D. Add Flat Washer, Lock Washer and Hex Nut to threaded rod of Floor Anchor above leveling bar.
- E. Tighten Hex Nuts with wrench to secure stile in place.
- F. Recheck vertical levelness. Tighten/loosen Hex Nut(s) as necessary.
- G. Level panel horizontally (front-to-back) by raising/lowering adjustable supports and inserting shims at wall.
NOTE: Ensure edge of panel is butted up against inline stile.
- H. Using the F-Brackets and Alcove Brackets as templates, drill 3/16" (4.7mm) pilot holes through the panel.
NOTE: Do NOT drill hole through F-Brackets.
- I. Fasten F-Brackets to panel with 1002499 Sheet Metal Screws - 7/16".
- J. Fasten Alcove Brackets to inline panel with 1002664 Button Head Screws - 3/8" and 1002666 Sex Bolt.

Fig. 8: Installing Adjacent Stile.

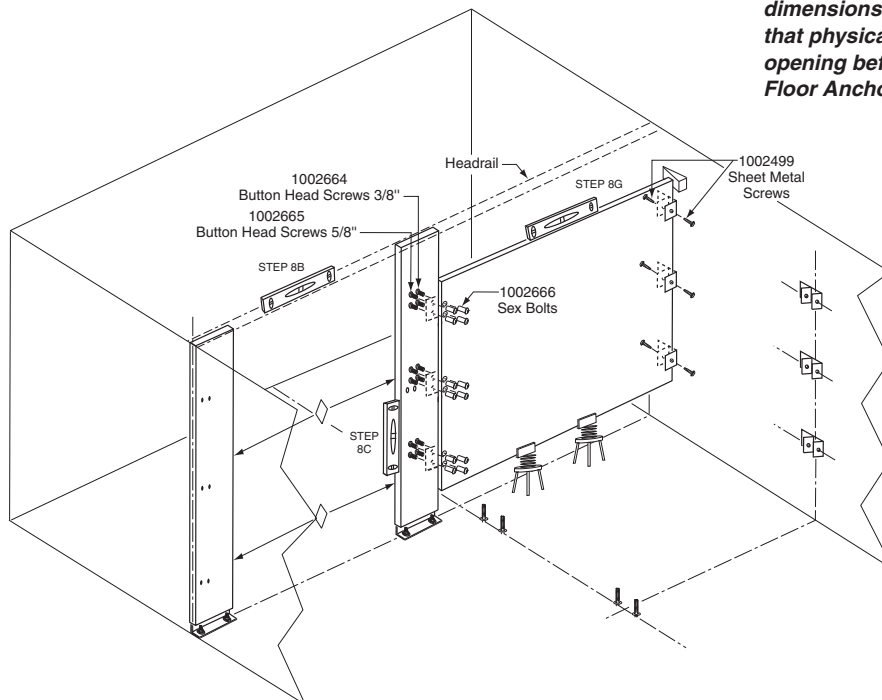

NOTE: Ensure that actual door opening between stiles matches opening dimensions on Layout Sheets. Verify that physical door will fit in actual door opening before securing Hex Nuts on Floor Anchors.

Front View

◇ Obtain dimension from Bobrick Layout Sheet.

STEP 9 INSTALL ADDITIONAL COMPARTMENT(S)

PARTS NEEDED:

Stile
 Panel
 1002385 Headrail
 1002499 Sheet Metal Screws - 7/16"
 1002664 Button Head Screw - 3/8"
 1002665 Button Head Screw - 5/8"
 1002666 Sex Bolt - 1/4" diameter, 1/2" barrel
 1000974 Y-Bracket
 Remaining components of 1002701 Floor Anchor
 (i.e., Flat Washer, Lock Washer, and Hex Nut)

TOOLS NEEDED:

Wrench (Crescent or with 9/16" open end)
 Drill
 T27 Pin-in-head Torx Driver
 3/16" (4.7mm) Drill Bit
 Shims
 Level

- A. Install and secure stile perpendicular to Alcove Panel with 1000974 Y-Brackets, using 1002664 Button Head Screws - 3/8" and 1002666 Sex Bolts (as shown in STEP 5a, pg. 8).
- B. Position adjacent panel (as shown in STEP 7, pg. 12).
- C. Set leveling bar of stile on top of Flat Washers of adjacent set of Floor Anchors.
- D. Level stiles by placing length of 1002385 Headrail over two adjacent stiles.
- E. Level stile by tightening/loosening 2nd Hex Nut of Floor Anchors.
- F. Add Flat Washer, Lock Washer and Hex Nut to threaded rod of Floor Anchor above leveling bar.
- G. Tighten Hex Nuts with wrench to secure stile in place.
- H. Recheck vertical levelness. Tighten/loosen Hex Nut(s) as necessary.
- I. Level panel horizontally (front-to-back) by raising/lowering adjustable supports and inserting shims at wall.
- J. Level stile vertically (top-to-bottom) by moving stile forwards/backwards.

NOTE: Ensure panel is butted up against screw heads that attach the 1000972 U-Brackets to the stile.

- K. Using the F-Brackets and U-Brackets as templates, drill 3/16" (4.7mm) pilot holes through the panel.

NOTE: Drill COMPLETELY through material. Do NOT drill hole through F- and U-Brackets.

- L. Fasten F- and U-Brackets to panel with 1002499 Sheet Metal Screws - 7/16".

Fig. 9: Installing Additional Compartment.

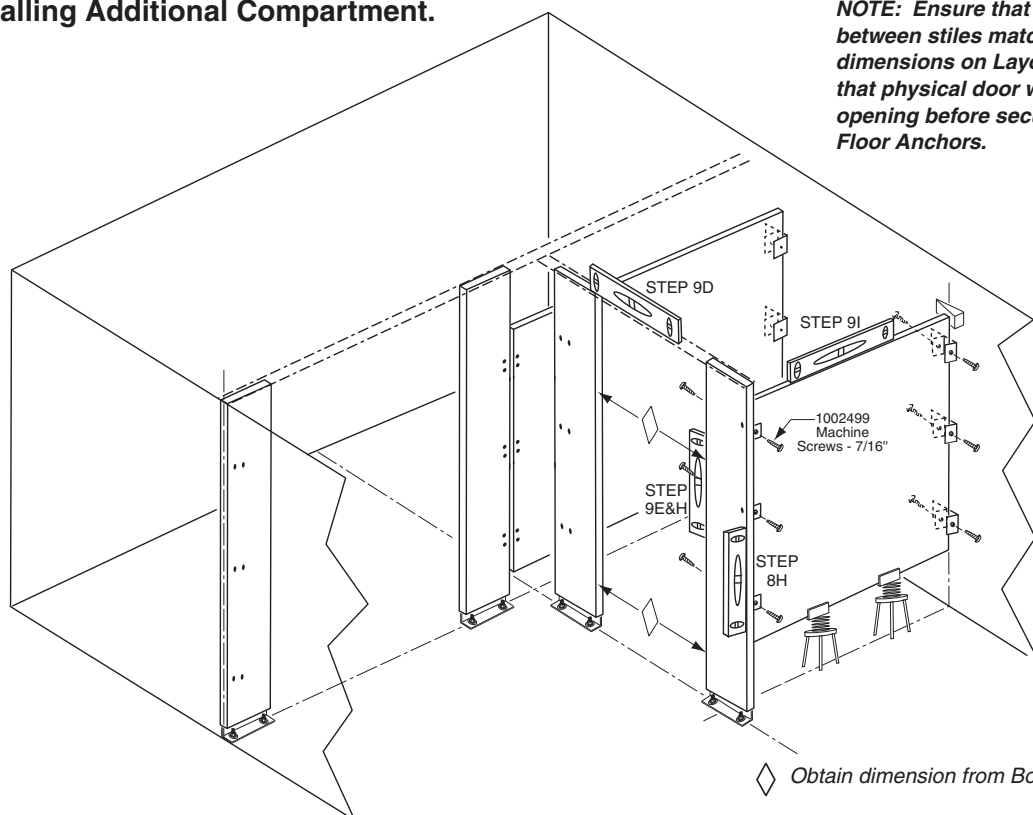

NOTE: Ensure that actual door opening between stiles matches opening dimensions on Layout Sheets. Verify that physical door will fit in actual door opening before securing Hex Nuts on Floor Anchors.

◇ Obtain dimension from Bobrick Layout Sheet.

HEAVY-DUTY HARDWARE

Front View

STEP 10 INSTALL DOORS

PARTS NEEDED:

- 1002330 L-Hinge Set
- 1002331 J-Hinge Set
- 1002156 Hinge Cam
- 1002491 Machine Screw - 1/2"
- 1001492 Latch Packet (includes Latch Cover, Latch Track, Flat Head Latch Screw, and Setscrew)
- 1000900 Allen Wrench - 5/64"
- 1002665 Button Head Screw - 5/8"
- 1002666 Sex Bolt
- 1000869 Clothes Hook

(For Inswing Doors):

- 1001518 Inline Stile Keeper
- 1000188 I/S Perpendicular Stile Keeper
- 1001675 I/S Wall-Mounted Keeper

(For Outswing Doors):

- 1000312 Door Handle Packet
- 1001518 Inline Stile Keeper
- 1000192 O/S Alcove Keeper

TOOLS NEEDED:

- Drill
- T27 Pin-in-head Torx Driver
- 17/64" Drill Bit
- Phillips Screwdriver

HINTS/NOTES:

17/64" (6.7mm) through-drilled hole needed to through-bolt Keepers-to-stiles and Clothes Hooks-to-doors using 1002666 Sex Bolts and 1002665 Button Head screw.

3/16" (4.7mm) through-drilled hole needed to attach Door Handle-to-doors using the fasteners provided in 1000312 Door Handle Packet.

Fig. 10a: INSWING Door Hardware.
(example)

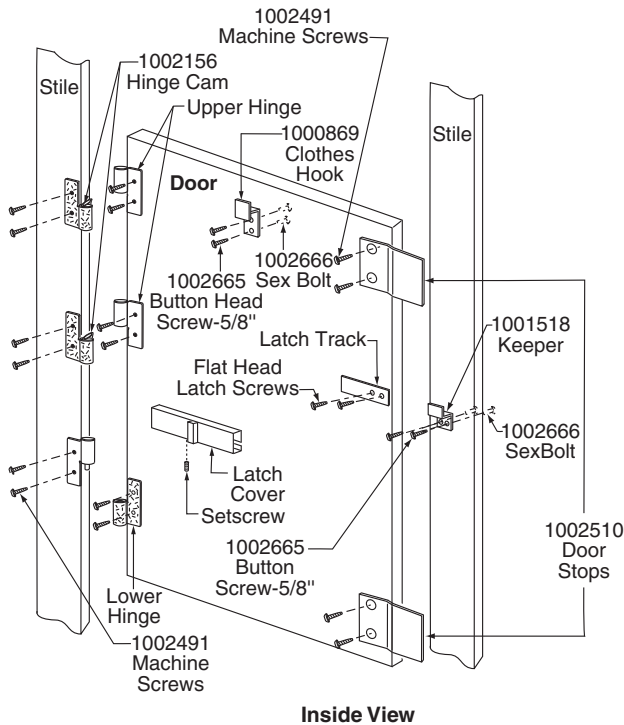
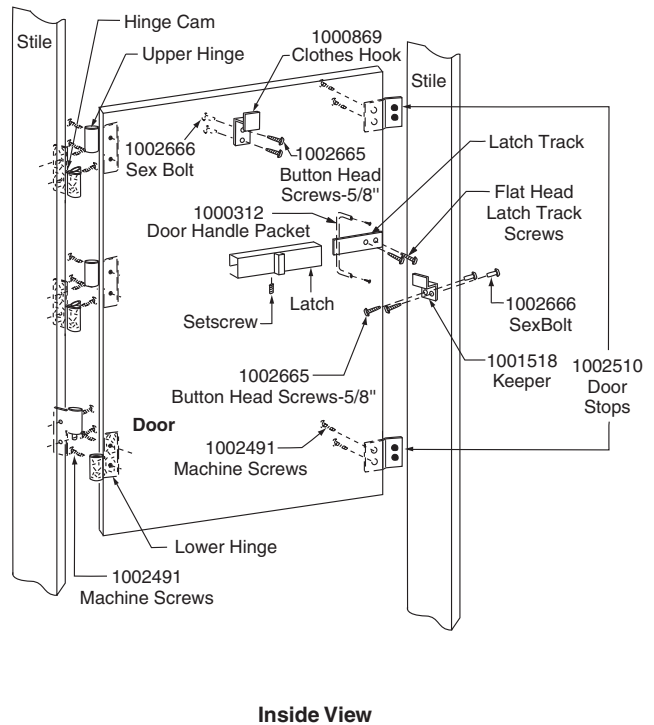

Fig. 10b: OUTSWING Door Hardware.
(example)



HEAVY-DUTY HARDWARE

STEP 10 INSTALL DOORS (HINGES AND DOOR HARDWARE)

Fig. 10c: INSWING Door Hinge Setup.

NOTE: Shading added to distinguish L- and J- hinges.

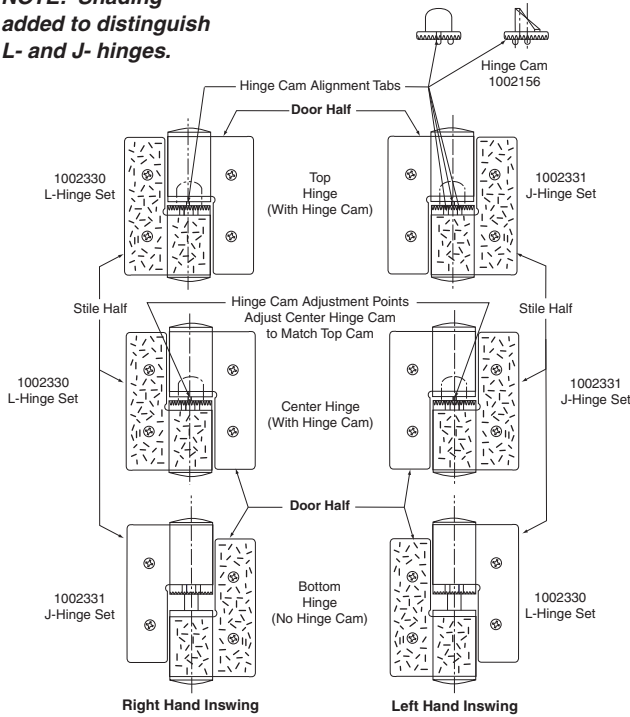
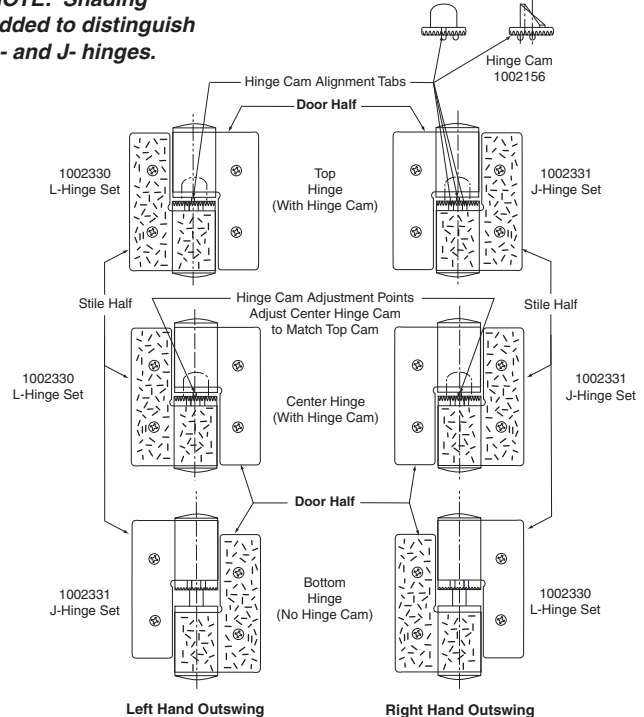

Fig. 10d: OUTSWING Door Hinge Setup.

NOTE: Shading added to distinguish L- and J- hinges.



Inside View

Outside View

ATTACHING HINGE: (for Inswing and Outswing Doors)

- Using hinge diagrams in Fig. 10c - 10d, identify the (2) upper and (1) lower hinge sets necessary for installation.
- Separate hinge sets. Fasten the (3) halves with "teeth" and cam alignment tabs onto stile using 1002491 Machine Screws - 1/2".
- Fasten (2) upper hinge halves to the door and stile using 1002491 Machine Screws.
- Insert (1) hinge pin and (1) 1002156 Hinge Cam on each of the upper two stile hinge halves.

NOTE: Hinge Cams on top and middle hinges must be set to same alignment tab position otherwise door may not function properly.

- Lift door and set into position onto (2) upper hinge halves. Door should be hanging securely on upper (2) stile hinge halves.
- Attach lower hinge and hinge pin onto door and stile with 1002491 Machine Screws.

CHANGING HINGE CAM STOP POSITION: (for Inswing and Outswing Doors)

- Lift door to limit of upward travel (approximately 1/2").
- Raise Hinge Cams from bottom bushings and rotate to different presets (on both top and middle hinges).

ATTACHING CLOTHES HOOK AND DOOR STOPS: (for Inswing and Outswing Doors)

- Place 1000869 Clothes Hook in desired position. Mark mounting hole locations.
- Drill 17/64" (6.7mm) hole through the door at locations marked in STEP A.
- Attach Clothes Hook to door using the 1002665 Button Head Screw - 5/8" and 1002666 Sex Bolt.

NOTE: For Barrier-Free compartments, position Clothes Hook per local codes.

- Attach 1002510 Door Stops to door with 1002491 Machine Screws.

ATTACHING DOOR HANDLE: (for Outswing Doors Only)

- Using the 1000312 Door Handle as template, mark location for handle so top hole is 27" (685mm) above bottom of the door and 3" (75mm) from the edge on the outside of the door. Mark location for bottom hole of Door Handle.
- Drill 3/16" (4.7mm) diameter holes through door at the locations marked in STEP A.
- Secure Door Handle to outside of door using the machine screws provided in the 1000312 Door Handle Packet.

STEP 10 INSTALL DOORS (LATCHES AND KEEPERS)

Fig. 10e: INSWING Door Keeper for Inline Stiles.

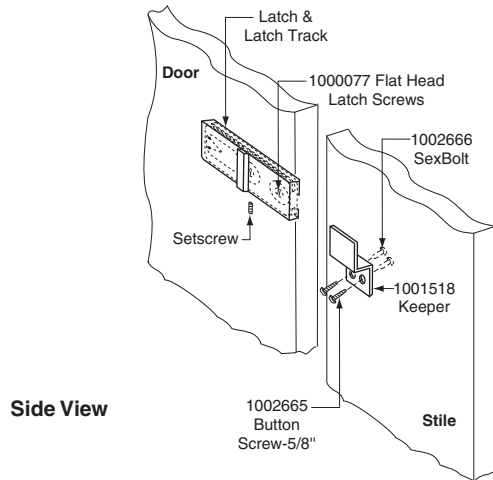
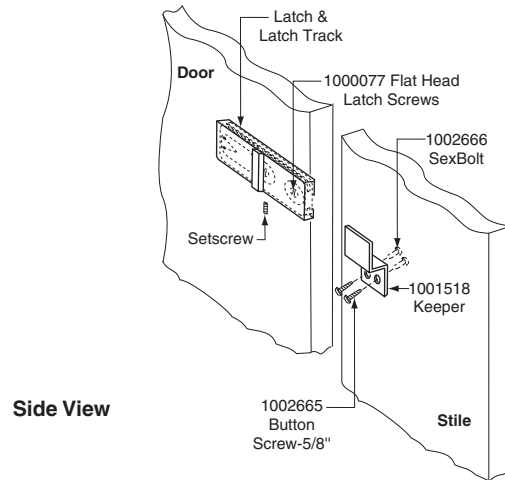
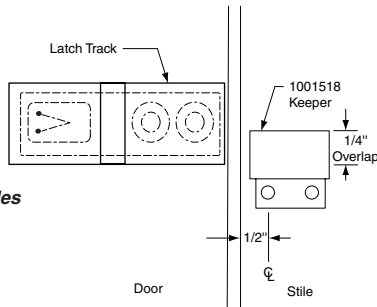

Fig. 10f: OUTSWING Door Keeper for Inline Stiles.



NOTE: Mounting holes should be mounted toward door edge.

Flat View



NOTE: Mounting holes should be mounted toward door edge.

Flat View

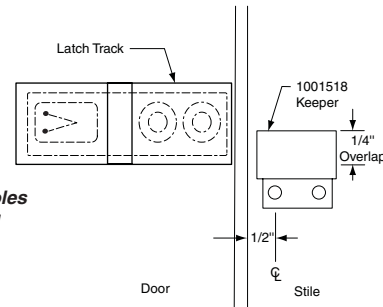

Fig. 10g: INSWING Door Keeper for Perpendicular Stiles.

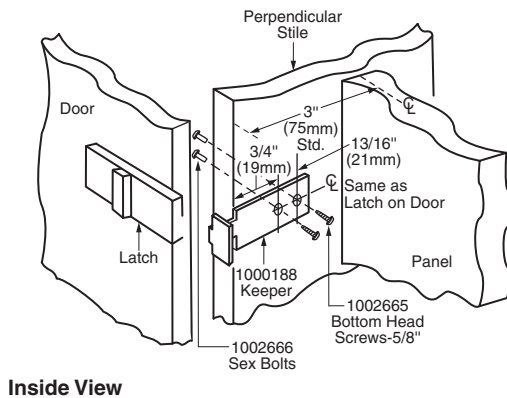
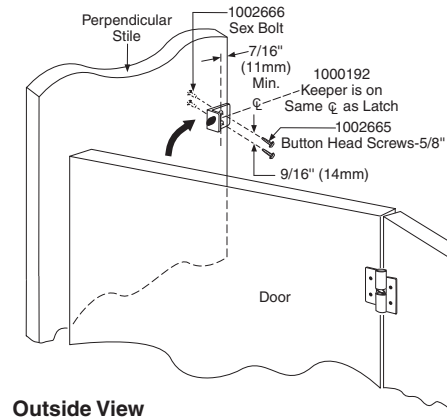

Fig. 10h: OUTSWING Door Keeper for Perpendicular Stiles.



ATTACHING LATCH AND KEEPER: (for Inswing and Outswing Doors)

- Attach the Latch Track to brass inserts in door with Flat Head Latch Screws using Phillips Screwdriver.
NOTE: Latch track should NOT project beyond door edge.
- Slide the Latch Cover into grooves of Latch Track.
- Secure Latch Cover to Latch Track with Setscrew using 1000900 Allen Wrench.
- Select appropriate Keeper as (see Figs. 10e - 10h). Position Keeper and mark mounting hole locations.
- Drill 17/64" (6.7mm) hole through the stile at locations marked in STEP D.
- Attach Keeper to stile using 1002665 Button Head Screws - 5/8" and 1002666 Sex Bolts.

STEP 11 INSTALL HEADRAIL AND CURTAIN TRACK (Optional)

PARTS NEEDED:

- 1002385 Headrail - 84"
- 1000927 Headrail Bracket
- 1000978 Headrail End Cap
- 1002495 Wall Screw - 2"
- 1002499 Sheet Metal Screw - 7/16"
- 1000375 Curtain Track (optional)
- 1000862 Curtain Carrier Pack (7 hooks/entrance) (optional)

TOOLS NEEDED:

- Drill
- T27 Pin-in-head Torx Driver
- 3/16" Drill Bit
- #19 (4.2mm) Drill Bit
- #25 (3.8mm) Drill Bit
- Hacksaw or Miter Saw

HINTS/NOTES:

- #19 (.166") x 2" (M4.2 x 50mm) pilot hole needed to fasten Headrail Bracket to stud backing using 1002495 Wall Screws.
- 3/16" (4.7mm) pilot hole size needed to fasten Headrail-to-stiles using 1002499 Sheet Metal Screws.

HEAVY-DUTY HARDWARE

- A. Measure wall-to-wall dimensions, less 1/4" (6mm). If it is a corner application, measure from wall to outside edge of stile, less 1/8" (3mm).
- B. Use hacksaw or miter saw to cut 1002385 Headrail to required length.
- C. Place Headrail over stile.
- D. Using the 1000927 Headrail Bracket as a template, mark mounting hole locations in the wall and Headrail.
- E. Drill 3/16" x 3/4" (M4.7 x 19mm) pilot holes through back of Headrail and stile. At wall locations, drill #19 (.166") x 2" (M4.2 x 50mm) pilot holes into stud wall backing or use other anchors appropriate for wall construction (*not furnished by Bobrick*).
- F. Fasten Headrail Bracket to front Headrail with 1002499 Sheet Metal Screws - 7/16" and to wall with 1002495 Wall Screws - 2".
- G. *For Corner and Alcove Layouts:* Cut additional return Headrail. Measure from the inside edge of front Headrail to the back wall (see Fig. 11b).
- H. Fasten return Headrail to stile by repeating STEPS D - F.
- I. *For Corner Layouts:* Install 1000978 Headrail End Cap to cover the exposed corner of Headrail. Using the Headrail End Cap as a template, mark and drill 3/16" (4.7mm) pilot hole and secure 1000978 Headrail End Cap with 1002499 Sheet Metal Screw.

Fig. 11a: Installing Headrail Hardware. (Corner Layout)

NOTE: Headrail Seams must be located over stiles for structural stability

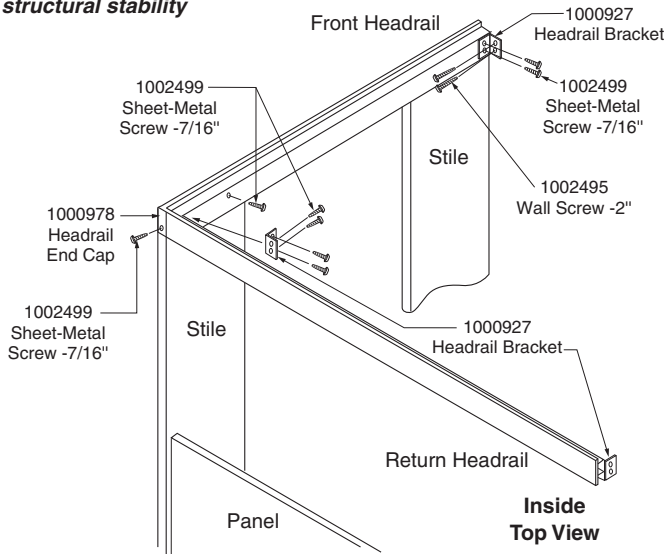
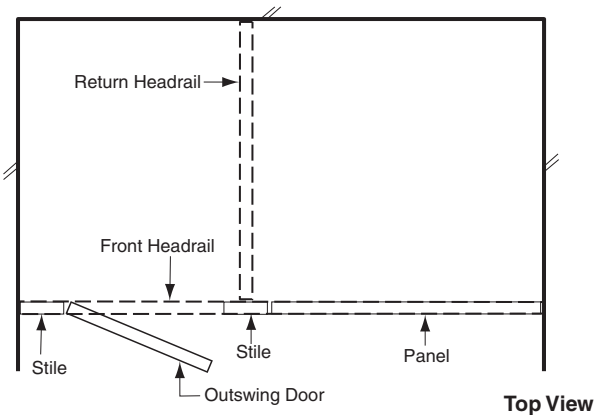

Fig. 11b: Headrail for Closed Alcove Layout.



*** NOTE: Do NOT forget the return headrail on Alcove Layouts.**

For Shower/Dressing Compartments (Installing Optional Curtain Track)

- A. Cut 1000375 Curtain Track to fit between stiles and fit inside headrail.
- B. Install 1000833 Curtain Carrier Hooks from 1000862 Curtain Carrier Packet into Curtain Track.
- C. Hold Curtain Track in place inside Headrail. Drill #25 (3.8mm) diameter hole through Curtain Track and Headrail.
- D. Fasten Curtain Track to Headrail using Curtain Track Screws provided in 1000862 Packet
- E. Install shower curtain (*not included*).

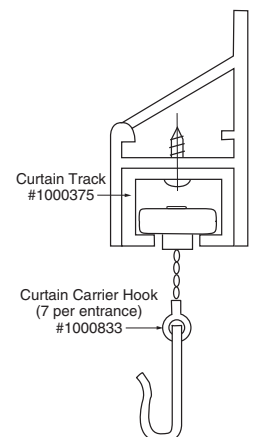

STEP 12 INSTALL SHOES

PARTS NEEDED:

- Appropriate Shoe (1002175 - 1002185)
- 1002185 Shoe Retainer Clip
- 1002189 Shoe Retainer Screw

TOOLS NEEDED:

- Phillips Screwdriver
- Pliers

- Locate appropriately sized Shoe for stile (see *Replacement Shoe Guide*, pg. 2).
- Confirm that the Flat Shoe Retainer is installed on the Floor Anchor above the Flat Washer closest to the floor. (For Floor Anchor assembly detail, see Fig. 2b, pg. 5).
- Shoes accommodate 3/4" or 1" thick stiles. For 3/4" stiles, orient Shoe with 5/16" wide flange return against faces and edge of stile.

D1. Shoe Installation for Free Standing Stile

- Open Shoe and slide over bottom of stile, trapping bottom flange of Shoe beneath Flat Shoe Retainer.
- Close open end of Shoe, overlapping edges so retaining holes are aligned.
- Install 1002189 Shoe Retainer Screw through double thickness of Shoe material to fasten Shoe into place.

D2. Shoe Installation for Stile Mounted Against Wall

- Install 1002185 Shoe Retainer Clip (included for stiles mounting to walls). Hold Shoe Retainer Clip leaf with pliers. Spread Shoe open at least 1" and insert Shoe Retainer Clip into hole on inner leaf of Shoe until Clip snaps into place.
- Slide Shoe over bottom of stile, trapping bottom flange of Shoe beneath Flat Shoe Retainer. Shoe Retainer Clip will be positioned against wall.
- Close edges of Shoe together.
- Apply pressure on Shoe until remaining hole snaps into place on Shoe Retainer Clip.

Fig. 12a: Installing Shoe on Free-Standing Stile.

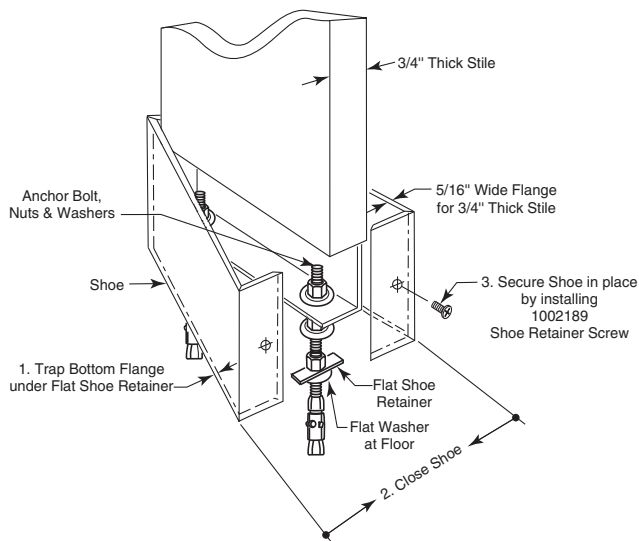
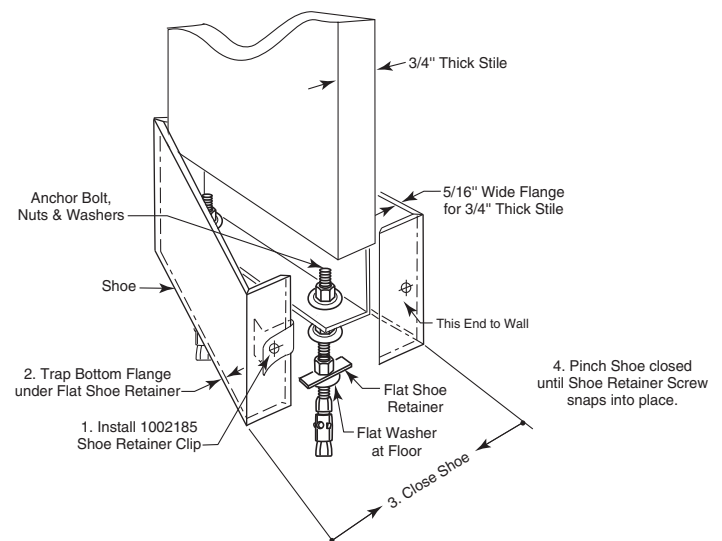

Fig. 12b: Installing Shoe on Stile Mounted Against Wall.



- Remove protective covering and wipe shoe clean.

STEP 13 FINISHING AND CLEANUP

- Remove any exposed labels from the components of toilet compartments.
- Clean surfaces as needed. **CAUTION: Do not use cleaners containing acids on Bobrick toilet compartments. For example, tile cleaners containing acid may attack the stainless steel hardware or the material surface. For Bobrick cleaning recommendations, refer to TB-21 and TB-60 or use Bobrick Graffiti Remover (Model #891099).**

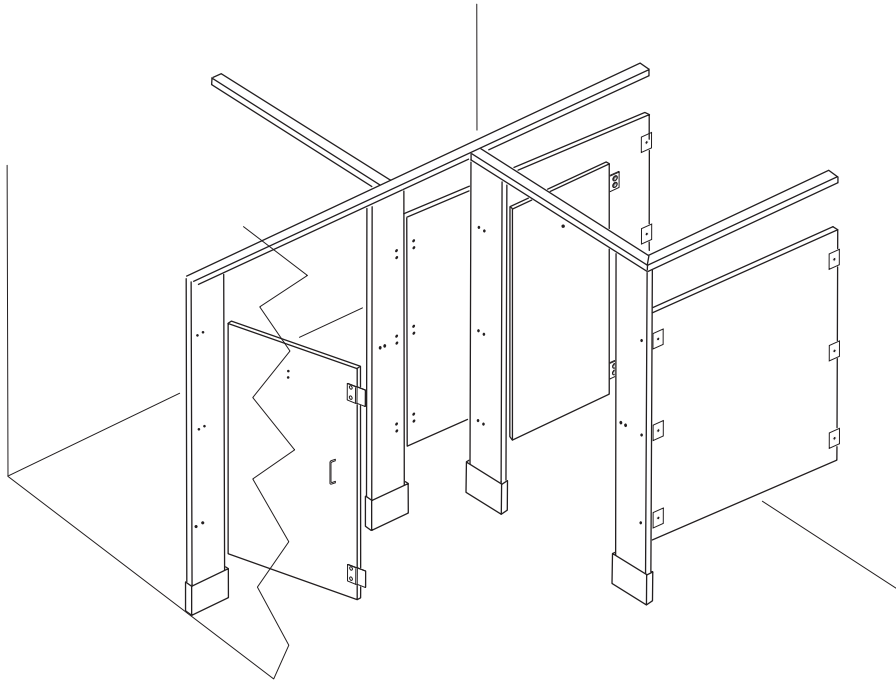

HEAVY-DUTY HARDWARE

**Important
Toilet Partition Storage and Handling Information**

Store in a clean, dry area. Do not store outside.
Move material to installation area 72 hours before installation.
Always store material flat with weight evenly supported.

Toilet Partition Stacking

Do This

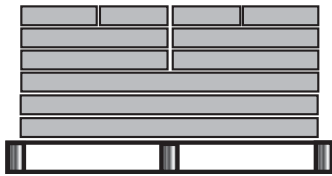

Stack Flat

Don't Do This

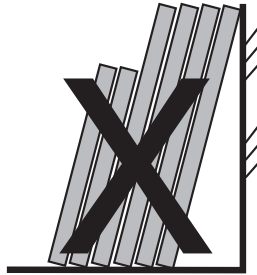

Stack Upright

Failure to follow these instructions may result in warped material which is not covered by Bobrick's warranty.



In the U.S.A.: BOBRICK WASHROOM EQUIPMENT, INC.

200 Commerce Drive, Clifton Park, New York 12065-1350 • Tel: (518) 877-7444 • FAX: 518-877-5029
11611 Hart Street, North Hollywood, California 91605-5882 • Tel: (818) 982-9600 • FAX: 818-503-1102

In Canada: BOBRICK WASHROOM EQUIPMENT COMPANY

45 Rolark Drive, Scarborough, Ontario M1R 3B1 • Ontario East: (877) 423-6555, FAX: (877) 423-8555
• Manitoba West: (877) 423-6444, FAX: (877) 423-8444

1092-69



7 16954 00936 4