

fino collection

Installation Instructions for Grab Bars B-9806 and B-9807



To ensure user, installer, and product safety, please use cut-resistant gloves before handling any material prior to installation.

NOTE:

For Installation on

- a. Dry-Walls
- b. Glass-Partitions and Metal Partitions as well as
- c. "back-to-back-installation of two grab bars against each other from opposite sides of partition-panels (glass and any other partition material)

Please see separate installation instructions of respected installation kits.

Required Tools

- a. Spanner (preferably ring end) 13mm (similar to 1/2")
- b. Laser/Spirit level
- c. Phillips head screwdriver
- d. six pcs. #10 sheet metal screws, flat head, stainless steel, length depending on application (e.g. 1/2" length for 1/2" material and 3/4" length for 3/4" material)



“Exploded” overview of the grab bar flange:

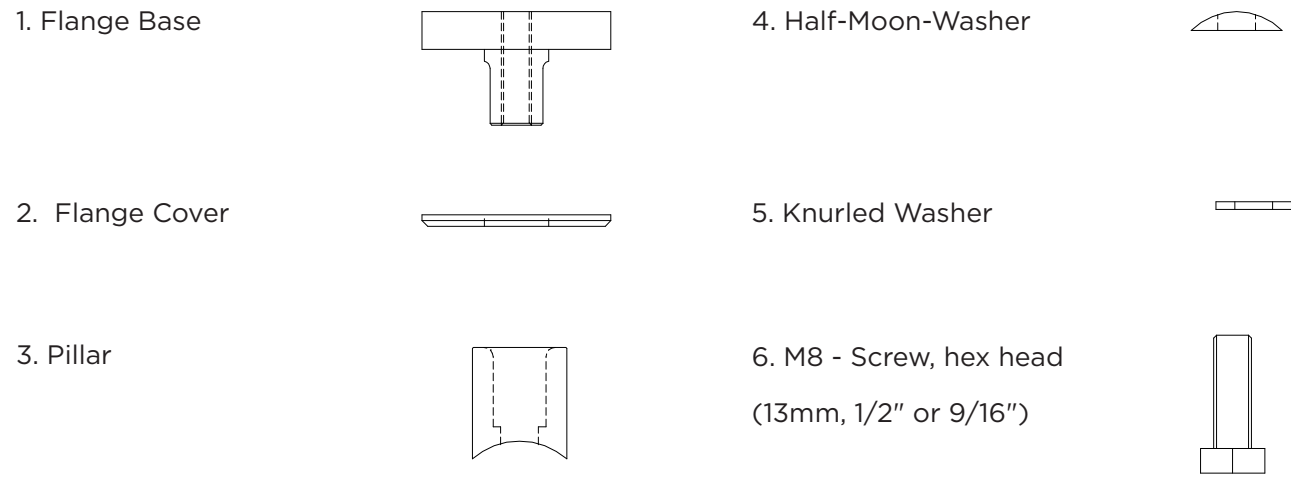

1. Securely fix flange-bases to panel/wall at correct pitch (18"/24"/36"/42") using the appropriate fixings (see also PCD-Pitch Circle diameter). Ensure a minimum of 6" from corners/returns so that a spanner can be used later.
2. Use base flange as a template to mark drilling holes on the wall with a pencil.
Base flange has 3 pcs. of 5.0mm (3/16") mounting holes, equally spaced 120° apart on a 38.0mm (1-1/2") Bolt/Pitch Circle Diameter (BCD/PCD).
Bobrick recommends using #10 Sheet metal screws, flat head, length depending on application. Screw heads want to be below flush. Use a level to assist in laying out.
Screw- and drilling examples :
 - a. #10 sheet metal screw, flat head, 1/2" screw length for 1/2" CL-partitions, 3/16" predrill
 - b. #10 sheet metal screw, flat head, 1" length for 1" thick particle board, 9/64" predrill

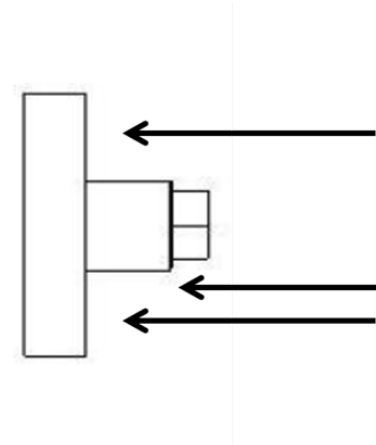

3. Fit the flange covers on both flanges with the bevelled edge facing out.

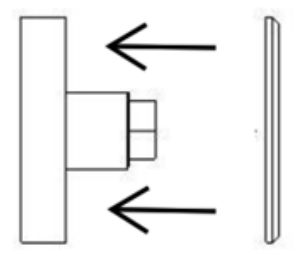

4. Place Pillars on both flanges with flat end to flange (flange cover).

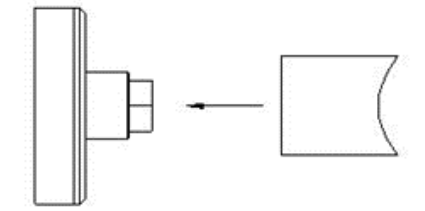

5. Fit Bolt (M8 Screw) & Knurled Washer through Half-Moon Washer.

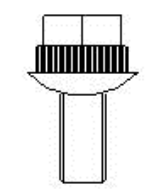

6. With the slots in the tube facing down, pass the thread of the bolt (M8 Hex Screw) through the slot in either end of the tube. Hold the tube and gently twist to help the bolt (M8 Hex screw) pass through the slot. Repeat for other end of the tube while keeping the slots facing down to avoid losing the part just fitted. Make sure the shape of the half-moon washer is aligned with the inside diameter of the tube.

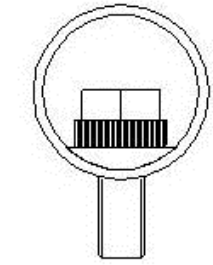

8. Push both threaded bolts (M8 Hex Screws) into flange end hole and finger tighten using the knurled washer on the bolt (M8 Hex Screw). Ensure the radius on the pillar matches the radius of the tube.

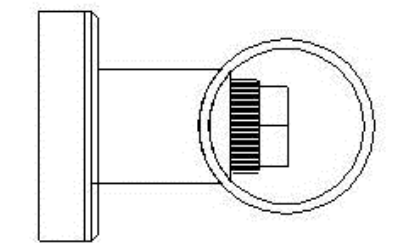

Tighten both ends with the ring end of a 13mm spanner making sure not to damage the tube with the spanner. Fit end caps making sure to locate the screwdriver release recess facing down out of casual observation.