

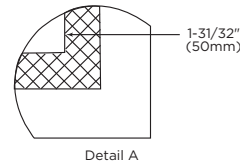

Technical Data

LED BACKLIT MIRROR (INNER ETCHED)

B-168

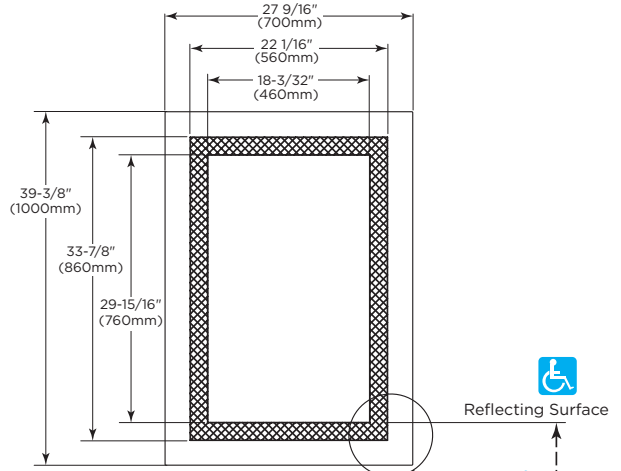
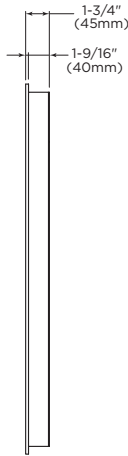
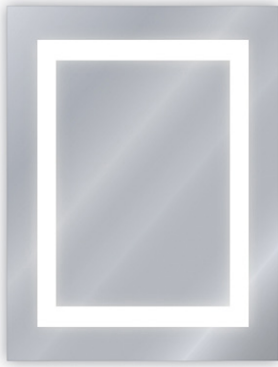

STANDARD B-168 MIRRORS

OVERALL SIZE

MODEL NO.	W	H	Lumens	Wattage
B-168 2739	27" (686mm)	39" (990mm)	2,500	26



ADA Installation Guidance

Maximum mounting height above lavatories and countertops:

ADA: 40" (1015mm) above finished floor (AFF)

*For more information regarding operable parts, please refer to Bobrick Planning Guide for Accessible Restrooms, page 9.

Designer's Notes:



- Mirrors are manufactured to a $\pm 0.04"$ (1mm).
- For sufficient space to lift mirror onto key hole slots allow 1".
- ADA requires mirrors located above lavatories or countertops shall be installed with the bottom edge of the unobstructed reflecting surface 40" (1015mm) maximum above the finish floor. Mirrors not located above lavatories or countertops shall be installed with the bottom edge of the unobstructed reflecting surface 35" (890mm) above the finish face of floor. For lit Mirrors this means the dimension is to the upper most edge of the lit portion at the bottom of the mirror.
- A single full length mirror can accommodate a greater number of people, including children.

MATERIALS:

Glass — 0.19" (5mm) thick safety mirror with 0.14mm PVC film backer with frosted sandblasting.

Extruded Back — Aluminum channel with mounting holes.

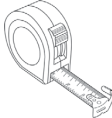
Optional 6V AC Adapter with U.S. Plug — Available. Order Part No. 164-57.

TOOLS NEEDED (Customer Supplied):		
		
Toggle Bolts (optional)	Tape Measure	Electric Drill

continued . . .

Safety Instructions:

- Disconnect power before installing, adding or changing any component.
- To avoid a hazard to children, account for all parts and destroy all packing materials.
- Do not install any luminaire assembly closer than 6" from any combustible materials.
- This power supply must be installed according to the National Electrical Code and local building codes.

INSTALLATION:

Mark the location of the wire exit and mounting holes. See individual product specifications for mounting hole locations. Install a duplex receptacle (not provided).

Bobrick offers a 90-degree plug (order 164-57); a straight plug would not fit unless using a recessed outlet, so the outlet should be installed a few inches away from the wire exit. Locating it too close to the wire exit may interfere with the power supply housing and prevent the mirror from being plugged in properly.

Install mounting screws into pre-marked holes. It is highly recommended that all mirrors be installed in contractor supplied blocking, however, drywall anchors may be used if no blocking is available.

For added safety, Bobrick recommends the 55-1/8" x 25-5/8" (1400 x 650mm) or larger edge lit mirror only be installed in blocking. If blocking is not available, drywall toggle bolts (not provided) should be used.

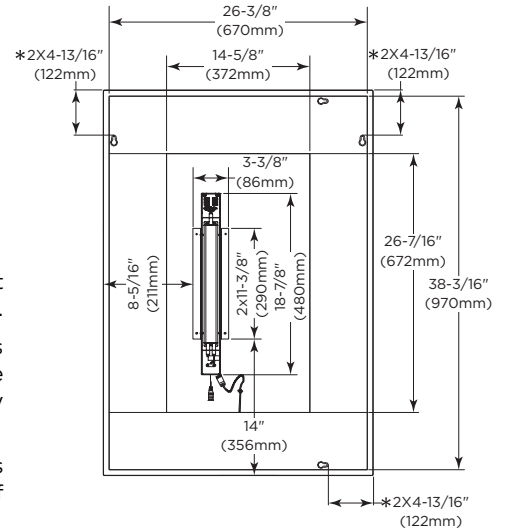

IMPORTANT SAFETY INSTRUCTIONS - SAVE THESE INSTRUCTIONS

Read all instructions before using this mirror.

DANGER - To reduce the risk of electric shock; Always unplug this mirror from the electrical outlet before cleaning.

WARNING - To reduce the risk of burns, fire, electric shock, or injury to persons:

- Unplug from outlet before putting on or taking off parts.
- Close supervision is necessary when this mirror is used by, or near children, invalids, or disabled persons.
- Use this mirror only for its intended use as described in these instructions.
- Never operate this mirror if it has a damaged cord or plug, if it is not working properly, if it has been dropped or damaged, or dropped into water.
- Keep the cord away from heated surfaces.
- Never drop or insert any object into any opening.
- Do not use outdoors.
- **WARNING:** Risk of electric shock - Connect this mirror to a properly grounded outlet only. See grounding instructions.

GROUNDING INSTRUCTIONS

This mirror is for use on a nominal 120V circuit and has an optional three prong grounding plug that looks like the plug illustrated in sketch below. Make sure that the mirror is connected to an outlet having the same configuration as the plug, No adapter should be used with this mirror.

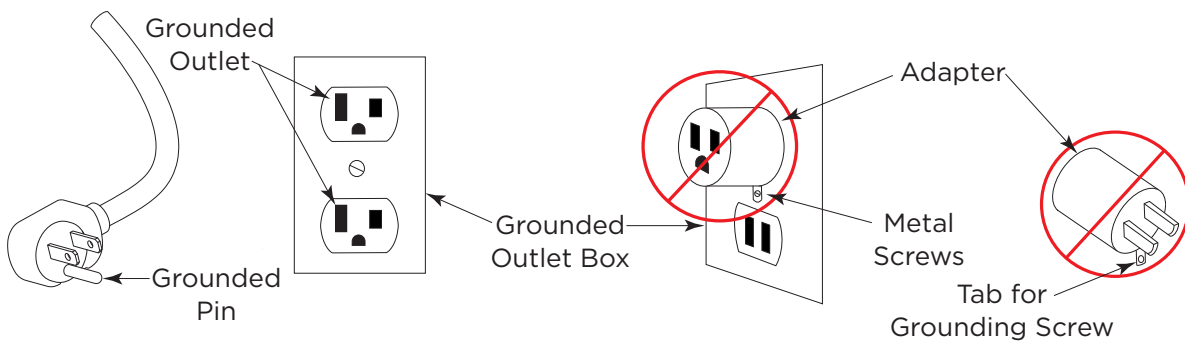

SPECIFICATION:

Mirrors shall have a 1mm thick anodized AL6061 frame. Integral UL recognized power supply must have 24V output and 110 - 277V input along with 0-10V dimming option. Reflective surface shall be 0.6" (1.5mm) thick and covered with a 0.14mm PVC film backer with frosted sandblasting. Lead free silver backing shall exceed ISO 9227:2012 and exceed 120-hour corrosion testing. Aluminum mounting panel shall contain key hole slots both top and bottom to provide easy installation and prevent the mirror from pulling away from the wall.

LED Backlit Mirror (Inner etched) shall be Model B-168 _____ (insert width and height) of Bobrick Washroom Equipment, Inc., Clifton Park, New York; Jackson, Tennessee; Los Angeles, California; Bobrick Washroom Equipment Company, Scarborough, Ontario; Bobrick Washroom Equipment Pty. Ltd., Australia; and Bobrick Washroom Equipment Limited, United Kingdom.